

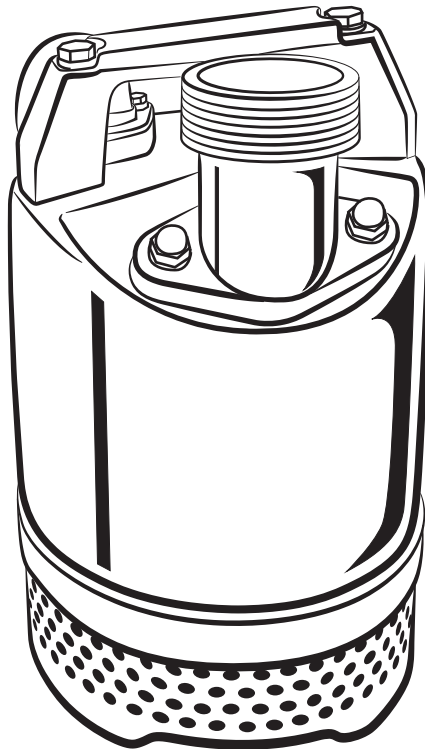

SP-20 / SP-25

Submersible Dewatering Pump

Operation Manual



OPERATION MANUAL

SUBMERSIBLE DEWATERING PUMP

Thank you for selecting SP-20/25 Submersible Pump for your pumping requirement.





Please take a moment to review this manual before, installing, operating or servicing these pumps.

The pump should not be used other than the applications listed in this manual. Failure to do so may lead to a malfunction or an accident to which the manufacturer will not assume any liability.

After reading this Operation Manual, keep it in a location where it can be referred to during the operational life of the pump.

In the event the product is damaged, please contact your authorized local dealer or sales representative.

SAFETY FIRST

	DANGER Indicates a hazardous situation which, if not avoided WILL result in DEATH, SERIOUS INJURY, PROPERTY DAMAGE.
	WARNING Indicates a hazardous situation which, if not avoided MAY result in DEATH, SERIOUS INJURY, PROPERTY DAMAGE.
	CAUTION Indicates a hazardous situation which, if not avoided MAY result in MINOR or MODERATE INJURY, PROPERTY DAMAGE.
	NOTICE Indicates special instructions which are very important and must be followed.

Content

I.	Safety Instructions.....	2
II.	Before you Start.....	2
III.	Pump Identification.....	3
IV.	Installation.....	4
V.	Pump Operation.....	5
VI.	Maintenance.....	6
VII.	Repair Parts.....	7
VIII.	Preventative Maintenance.....	8
IX.	Trouble Shooting.....	9
X.	Product Disposal.....	9

I. SAFETY INSTRUCTION

WARNING

All electrical work must be performed by an authorized electrician, in compliance with local electrical codes. **NEVER**, allow an unauthorized person to perform electrical work as it could lead to electrical shock, fire, or damaging the pump.

- Risk of Electrical Shock. The pump comes supplied with a grounding conductor and a grounding type attachment plug. **NEVER**, operate a pump with a plug in type power cord without a ground fault circuit interrupter. Keep power end connection dry.

II. BEFORE YOU START

- Upon receiving the pump, inspect for damages or shortages.
- Check the name plate of the pump to ensure product is of the correct specification you ordered. Ensure that the voltage and frequency are correct.
- **NEVER**, pump water with a temperature greater than 30°C.

WARNING

- **NEVER**, use the power cord to lift or lower the pump. **ALWAYS**, tie a chain or rope to the handle of the pump to lift and lower the pump.
- **NEVER**, splice or use damaged or worn cables and cords.
- **ALWAYS**, disconnect the electrical power before servicing the pump.
- **DO NOT**, pump liquids which are flammable.
- **DO NOT**, operate pump in a hazardous environment.
- Risk of Electric Shock, this pump has not been investigated for use in a swimming pool application.



CAUTIONS

- When installing the pump, be mindful of the pump's center of gravity and weight. Failure to do so, may result in the pump to fall and break which may lead to injury.
- This pump is **NOT** designed for applications involving Acid, or Alkaline.
- **NEVER**, operate the pump dry. Doing so will damage the seals and overheat the motor.
- Periodically, check the oil level and water in the seal chamber. Check the seal condition quarterly for heavy duty applications or annually otherwise.

This manual does not fully cover all safety issues. For this reason, the person using or maintaining the pump must pay special attention to their own safety as well as those around.

III. PUMP IDENTIFICATION

Please check the nameplate on the received pump against your ordered pump. Paying special attention to the Model, Output(Hp), Voltage and Frequency.

			
Model:			
Bore:	in	Output:	hp
Hertz/PH:	hz Ø	Volt:	V
HD Max:	ft	AMP:	A
Max Flow:	gpm	RPM:	rpm
Ins:		Top View Rotation 	
Made in Taiwan		Teral Inc.	

IV. INSTALLATION

Pump Mount

NOTICE

- **ALWAYS**, place the pump in an upright position. Ensure, that the pump will not burrow itself on the soft sand or mud.
- **NEVER**, allow the pump to freeze in the liquid it is pumping.

Piping

NOTICE

- All piping must be independently supported, properly aligned and capable of handling semi-solids.
- **DO NOT**, restrict the discharge flow of the pump as it will cause the pump to overheat.
- Be mindful of the discharge hose whipping under pressure.
- To avoid backflow or outflow of the pump. Backflow, discharge hose is above the water surface. Outflow, the discharge hose is above the source water surface.

Electrical

WARNING

The electrical voltage required to operate this pump can burn, shock, or even cause death. Before, installing, operating or servicing this pump, please thoroughly read this manual.

- **DO NOT**, splice the power cord.
- **DO NOT**, handle or service the pump while it is connected to the power supply.
- **ALWAYS**, ensure that the voltage and frequency supplied to the pump are correct. Refer to the nameplate to determine the correct voltage and frequency.
- **ALWAYS**, make sure the pump is grounded properly in accordance to local law. **DO NOT**, connect the ground wire to gas pipe, water pipe, etc... as improper grounding will result in electrical shock.

**DANGER**

DO NOT operate this pump anywhere near explosive or flammable material. Serious personal injury, death, or major property damage will result.

**WARNING**

Accidental starting of the pump can cause severe injury or death.

- It is absolutely essential that the rotation of the pump be checked. All the pumps covered in this manual turn clockwise as viewed from the motor end.
- This pump comes with a built in motor protector. In the event of a current overload or overheating, the pump will stop automatically to protect the motor. After the motor cools down, the motor protector will automatically reset and the pump can be used again.
- If the motor protector trips frequently, check for the cause. It could be due to impeller blockage, wrong/low voltage, etc...
- For Automatic operation, the pump must stop before the water level reaches Pump Minimum Water Level.(W.M.L.)

VI. MAINTENANCE

If the pump must be disassembled for repair, please contact an Authorized Dealer in your area.

WARNING

Accidental starting of the pump can cause severe injury or death. **ALWAYS**, disconnect the electrical power before examining/working on the pump. For heavy parts, use a hoist lift to avoid injury.

CAUTIONS

Disassembling the pump or modifying the pump will void manufacturer warranty. **ALWAYS**, check that the voltage and amperage readings are in line with the nameplate of the pump. Check if the water level is normal.

STORAGE:

NOTICE

If the pump will not be used for a long period of time, wash the pump under tap water removing any debris. Allow the pump to dry and then store indoors. Before, reinstalling perform a test run to ensure it is operating correctly and within the parameters stated on the nameplate

VII. REPAIR PARTS

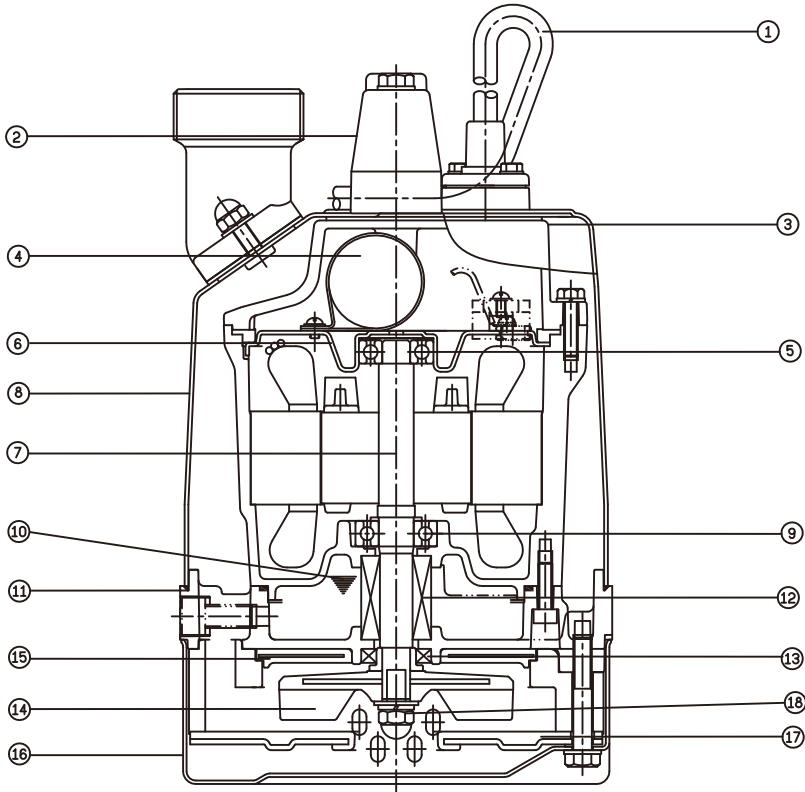

NO.	PART NAME	NO.	PART NAME	NO.	PART NAME
1	CABLE	8	OUTER COVER	15	WEAR PLATE
2	HANDLE	9	BEARING	16	STRAINER
3	UPPER COVER	10	LUBRICANT	17	CASING COVER
4	CAPACITOR	11	OIL PLUG GASKET	18	CAP NUT
5	BEARING	12	M. SEAL		
6	BRACKET	13	OIL SEAL		
7	SHAFT	14	IMPELLER		

VIII

PREVENTATIVE MAINTENANCE

Daily	<p>1.Ensure the Voltage and Amperage conform to the nameplate. Voltage must be within 10% of nameplate voltage.</p> <p>2.Check if the water flow is normal.</p>
Monthly	Maintenance is recommended when the insulation reading is lower than $10M\Omega$.Replace new motor immediately when insulation is lower than $1M\Omega$.
Annual	<p>Inspecting of Lubricant:</p> <ul style="list-style-type: none"> ●For pumps ≤ 1hp, the item should be checked every 3000 hours or 12 months (whichever comes first). ●For pumps ≥ 2hp, the item should be checked every 6000 hours or 12 months (whichever comes first). <p>PS: Loosen the oil plug screw and check the color of the lubricant. If the lubricant is non-translucent, please change the mechanical seal and the lubricant immediately. Apply adhesive before resealing the oil plug screw to strengthen the screw against leakage.</p>
Biennial	<p>1.Replacing Lubricant:</p> <ul style="list-style-type: none"> ●For pumps ≤ 1hp, the item should be replaced every 4500 hours or 24 months (whichever comes first). ●For pumps ≥ 2hp, the item should be replaced every 9000 hours or 24 months (whichever comes first). <p>2.change mechanical seal : Inspecting and replacing the mechanical seal . Only qualified mechanics with proper tools and knowledge should be attempting to service this pump or contact our authorized local dealer in your area.</p>
Every 2~5 Years	<p>1.During the typical operating cycle, it is recommended to have the pump overhauled and inspected periodically. This preventative maintenance activity can extend the pump operating life cycle.</p> <p>2.Please contact your authorized local dealers.</p>

Please record the following information for future reference:

Model Number:

Serial Number:

Purchase Date:

IX TROUBLESHOOTING

Hazardous voltage can shock, burn, or kill. Disconnect the electrical power before attempting any service or repair work on pump.

SYMPTOM	PROBABLE CAUSE	SOLUTION
Pump Fails to Start	Incorrect Voltage/Amps	Check power and correct connections.
	Defective Cable	Replace Power Cable
	Clogged Impeller	Remove foreign debris from impeller or casing.
	Non Functioning Motor Protector	Replace with new protector.
	Burned Out Motor	Replace Motor
	Defective Float Switch	Replace Float Switch
	Bad Control Panel	Repair or Replace Control Panel
Pump Starts but Immediately Stops	Jammed Impeller	Remove foreign debris from impeller or casing.
	Irregular Voltage	Check power to ensure it corresponds to the nameplate
	Tripped Motor Protector	Check if pump is completely submerged. Ensure the liquid temperature being pumped is below 30°C.
Fails to Deliver Full Output	Incorrect Rotation	Change the power connection
	Worn Out or Damaged Impeller	Change the Impeller.
	Strainer is clogged	Remove debris
	Obstruction in Valves and Pipes.	Remove obstruction
ELCB Trips	Damaged Power Cable	Replace with new cable
	Wet Cable Terminals	Reconnect after drying out.
	Worn out mechanical seal causes water to enter.	Replace mechanical seal and oil seal
	Burned out Motor	Replace with new motor.
High Amperage	Irregular Voltage	Check the power to make sure it corresponds to the nameplate.
	Incorrect Rotation	Change the power connection
	Highly Viscous Liquid	Decrease the viscosity of the liquid
	Debris inside the pump	Remove debris from the pump.
	Damaged Bearings	Replace with new Bearings.

X PRODUCT DISPOSAL

Properly dispose the product in accordance with your local waste disposal program.

patron[™]

PATRON PRODUCTS

A Division of Rentquip

1-800-818-1199

www.patronproducts.com